

Article number: 439600260

Description: Rota-fix shaft-hub connection FS260x325

Note: Self centering - very high torque.

Measures

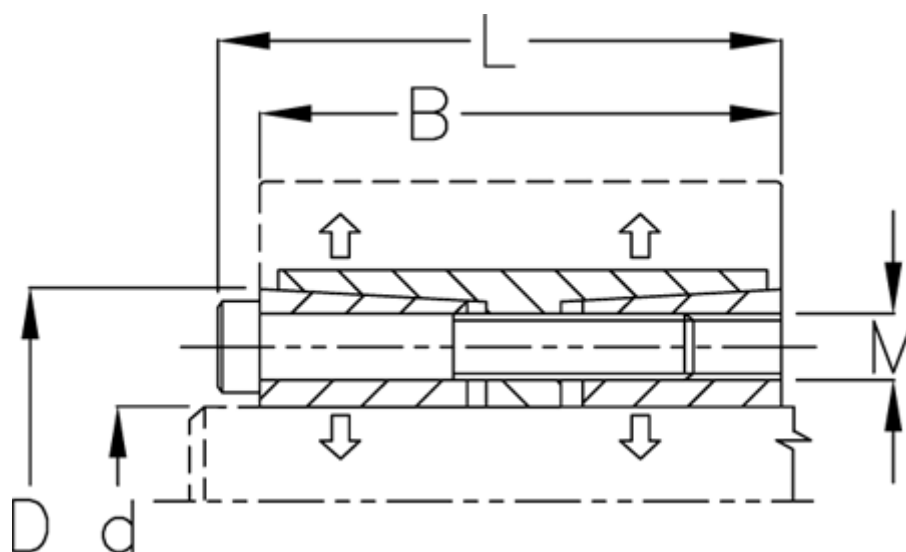

B mm	= 111
d H8 mm	= 260
D mm	= 325
Fit tolerance	= Aksel h8, Nav H8
F kN torque	= 1519.0
L mm	= 127
M mm	= M16
P N/mm ² surface pressure on shaft/hub	= 129

Surface roughness	= R? ? 3.2 μm
T N m torque	= 197500
Ts N m bolt tightening torque	= 355.0